

Relay Control

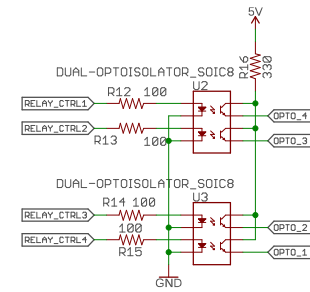

Power

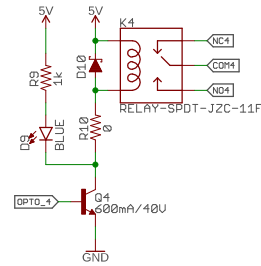
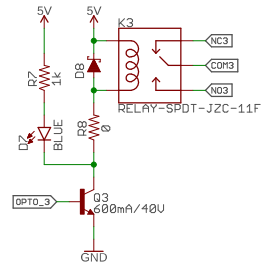
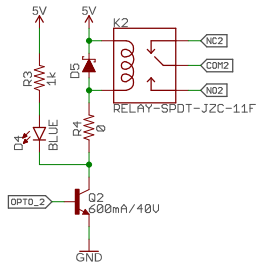
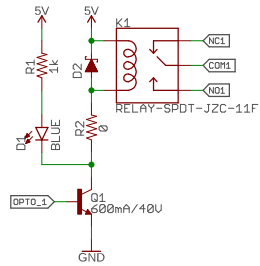
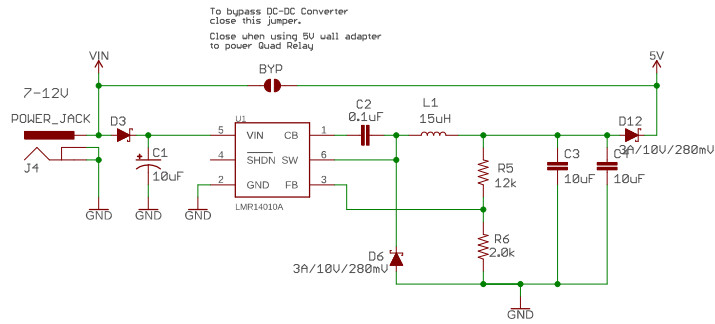

ATTiny84

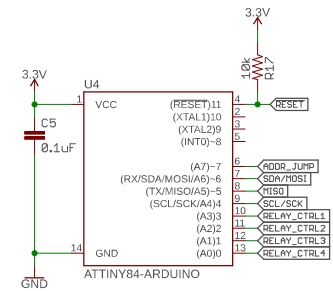

Connectors

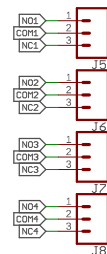
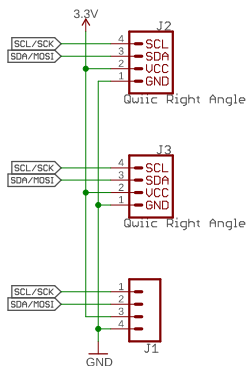

Programming Header

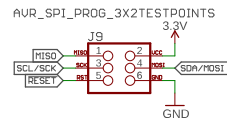

Jumpers

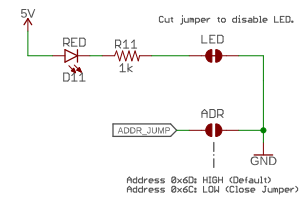

Released under the Creative Commons
Attribution Share-Alike 4.0 License
<https://creativecommons.org/licenses/by-sa/4.0/>

TITLE: Quiic_Quad_Relay

Design by:
Elias Santistevan

REV:
v20

Date: 7/24/2020 9:46 AM

Sheet: 1/1