

1

Resistor - Weerstand - Résistance - Widerstand - Resistencia - Motstand - Vastus - Resistenze

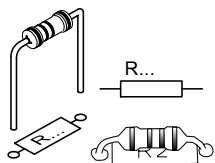

R1 ... R4: 1K	(Brown, Black, Red) - (Bruin, Zwart, Rood) - (Brun, Noir, Rouge) - (Braun, Schwarz, Rot) - (Brun, Svart, Röd) - (Ruskea, Musta, Punainen) - (Marrón, Negro, Rojo) - (Castanho, Preto, Encarnado) - (Marrone, Nero, Rosso)
R5,R6: 82K	(Grey, Red, Orange) - (Grijs, Rood, Oranje) - (Gris, Rouge, Orange) - (Grau, Rot, Orange) - (Grå, Röd, Orange) - (Harmaa, Punainen, Oranssi) - (Gris, Rojo, Naranja) - (Cincento, Encarnado, Laranja) - (Grigio, Rosso, Aranciato)
R7,R8: 100K	(Brown, Black, Yellow) - (Bruin, zwart, Geel) - (Brun, noir, Jaune) - (Braun, Schwarz, Gelb) - (Brun, Svart, Gul) - (Ruskea, Musta, Keltainen) - (Marrón, Negro, Amarillo) - (Castanho, Preto, Amarelo) - (Marrone, Nero, Giallo)

2

ELECTROLYTIC CAPACITOR

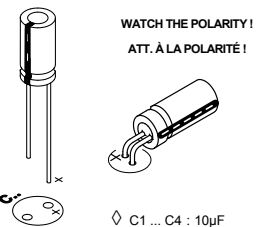

4

LEDs

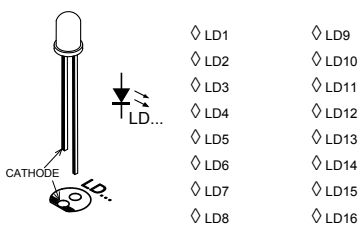

- ◇ LD1
- ◇ LD2
- ◇ LD3
- ◇ LD4
- ◇ LD5
- ◇ LD6
- ◇ LD7
- ◇ LD8
- ◇ LD9
- ◇ LD10
- ◇ LD11
- ◇ LD12
- ◇ LD13
- ◇ LD14
- ◇ LD15
- ◇ LD16

3

TRANSISTOR

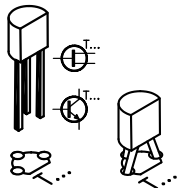

Watch the polarity!
Att. à la polarité!

◇ T1 ... T4 : BC547

5

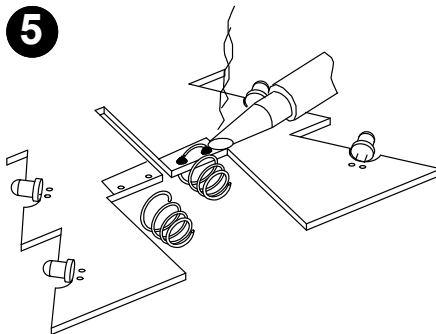

7

WIRE JUMPERS

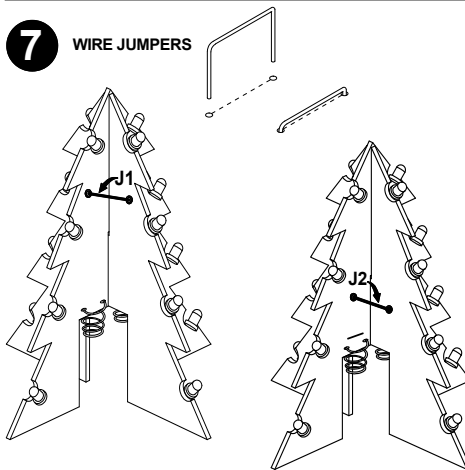

6

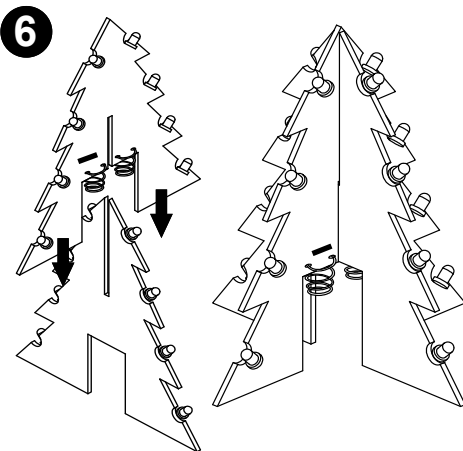

8

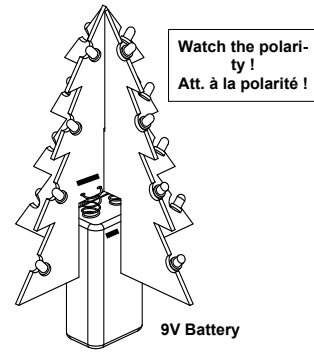

9V Battery

