

Total solder points: 202

Difficulty level: *beginner* 1 2 3 4 5 *advanced*

POWER SAVER / TIMER

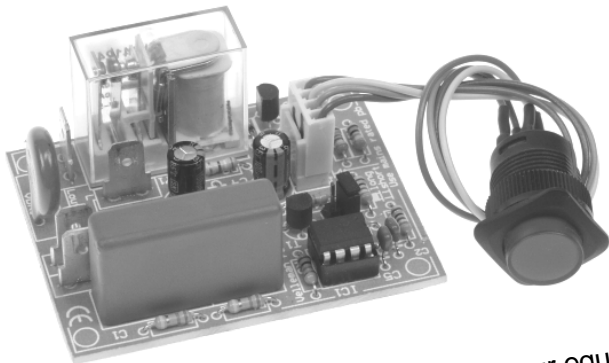

K8075

Turns off your equipment after a preset time, it helps you save money and it increases safety

The power saver turns off your equipment after a preset time. It helps you save money and it increases safety.

FEATURES:

- Single button operation with LED mode indicator
 - *continuous* : 24h turn-off timer
 - *slow flashing* : 4h or 8h turn-off timer
 - *fast flashing* : 1h or 2h turn-off timer
 - *dim* : idle
- Choose short or long-running timers (one-time jumper setting)
- 10A suppressed relay output
- Easy to add to existing equipment

Applications: automatically turn off heating, cooling, lighting, entertainment systems, fans, pumps, sprinklers, etc...

SPECIFICATIONS:

- Available timers: 1h / 2h / 4h / 8h / 24h
- Relay output: 10A / 240VAC max
- Power supply: 100 - 240VAC
- Dimensions: 65 x 50 x 26mm

1. Assembly (Skipping this can lead to troubles !)

Ok, so we have your attention. These hints will help you to make this project successful. Read them carefully.

1.1 Make sure you have the right tools:

- A good quality soldering iron (25-40W) with a small tip.
- Wipe it often on a wet sponge or cloth, to keep it clean; then apply solder to the tip, to give it a wet look. This is called 'thinning' and will protect the tip, and enables you to make good connections. When solder rolls off the tip, it needs cleaning.
- Thin rosin-core solder. Do not use any flux or grease.
- A diagonal cutter to trim excess wires. To avoid injury when cutting excess leads, hold the lead so they cannot fly towards the eyes.
- Needle nose pliers, for bending leads, or to hold components in place.
- Small blade and Phillips screwdrivers. A basic range is fine.

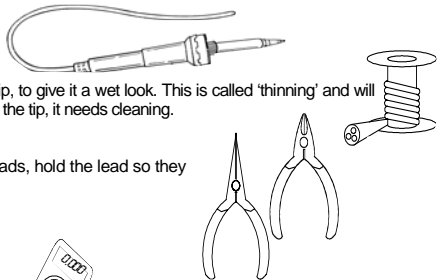

For some projects, a basic multi-meter is required, or might be handy

**1.2 Assembly Hints :**

- ⇒ Make sure the skill level matches your experience, to avoid disappointments.
 - ⇒ Follow the instructions carefully. Read and understand the entire step before you perform each operation.
 - ⇒ Perform the assembly in the correct order as stated in this manual
 - ⇒ Position all parts on the PCB (Printed Circuit Board) as shown on the drawings.
 - ⇒ Values on the circuit diagram are subject to changes.
 - ⇒ Values in this assembly guide are correct*
 - ⇒ Use the check-boxes to mark your progress.
 - ⇒ Please read the included information on safety and customer service
- * Typographical inaccuracies excluded. Always look for possible last minute manual updates, indicated as 'NOTE' on a separate leaflet.

1.3 Soldering Hints :

1- Mount the component against the PCB surface and carefully solder the leads

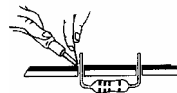

2- Make sure the solder joints are cone-shaped and shiny

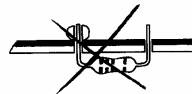

3- Trim excess leads as close as possible to the solder joint

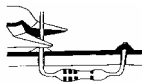

REMOVE THEM FROM THE TAPE ONE AT A TIME !

**AXIAL COMPONENTS ARE TAPED IN THE
CORRECT MOUNTING SEQUENCE !**

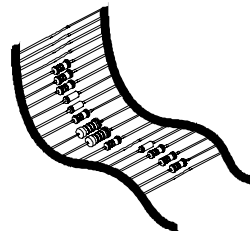

You will find the color code for the resistances on our website:

<http://www.velleman.be/common/service.aspx>

1. Diodes. Watch the polarity !

D1 : 1N4148

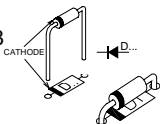
**2. Zenerdiodes. Watch the polarity !**

ZD1 : 5V/0.5W
 ZD2 : 24V/1.3W

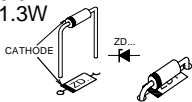
**3. Diodes. Watch the polarity !**

D2 : 1N4007
 D3 : 1N4007
 D4 : 1N4007
 D5 : 1N4007

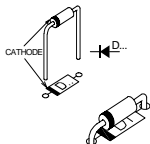
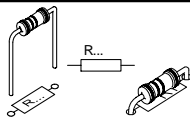
**4. Metal film resistors (1%)**

R1 : 330K (3-3-4-B-9)
 R2 : 330K (3-3-4-B-9)
 R3 : 220 (2-2-1-B-9)

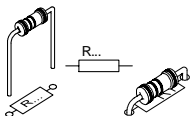
5. Resistors

R4 : 47K (7-7-3-B)
 R5 : 1K (1-0-2-B)
 R6 : 1K (1-0-2-B)
 R7 : 10K (1-0-3-B)
 R8 : 10K (1-0-3-B)
 R9 : 10K (1-0-3-B)
 R10 : 2K2 (2-2-2-B)
 R11 : 6K8 (6-8-2-B)
 R12 : 3K9 (3-9-2-B)

6. IC socket. Watch the position of the notch!

IC1 : 8p

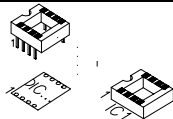
**7. Capacitors.**

C1 : 100nF (104)
 C2 : 100nF (104)

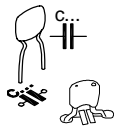

8. Transistors

- T1 : BC547B
- T2 : BC547B

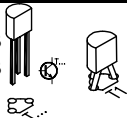

9. Board to wire connector

- SK6 : 4p

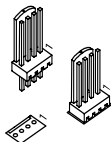

10. Pin header

- JP1 : 2p

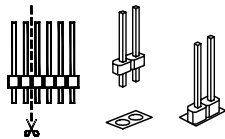

11. Shunt

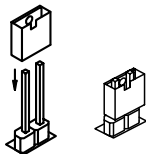

Choose timer :

- Mounted : 2h / 8h
- Not mounted : 1h / 4h

12. PCB terminals

- L AC power out
- N

- L AC power in
- N

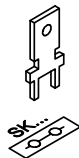

13. VDR

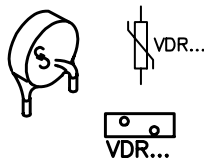

- VDR1 : VDR300

14. Electrolytic capacitors Watch the polarity!

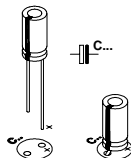

- C3 : 100µF / 35V
- C4 : 100µF / 35V

15. Capacitor

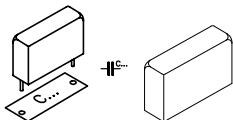

Choose operation voltage :

230V :

C5 : 0,47 μ F / 630V

115V :

C5 : 0,68 μ F / 400V

16. Relays

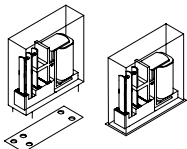

RY1 : VR10V241C
(24DC - 10A - 1contact)

17. IC. Watch the position of the notch!

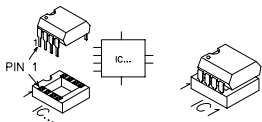

IC1 : VK8075
(programmed PIC10F200-I/PG)



☞ CHECK THOROUGHLY ALL THE COMPONENTS FOR MISS MOUNTING, INCLUDING SOLDERING ERRORS.

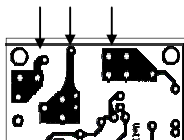

☞ PUT AN EXTRA THICK LAYER OF SOLDER ON THESE PCB TRACKS TO IMPROVE THEIR CURRENT HANDLING CAPACITIES.

Fig. 1.0

18. Wiring the push button

- Cut off a piece of shrinkable tube with a length equal to 2,5cm.
- Slide the shrinkable tube over the wires of the female 'board to wire'-connector (fig. 2.0)
- Solder the 4-pole female 'board to wire' connector to the push button using the figure below to check the accuracy of the connections (see figure 3.0)

Attention: Always make sure to slide down the shrinking tube far enough from the soldering points!

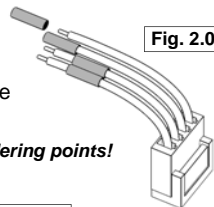

Fig. 2.0

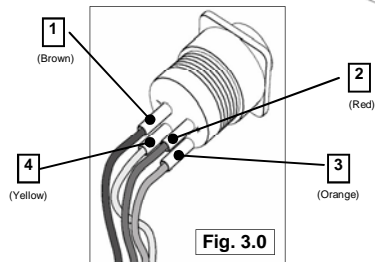
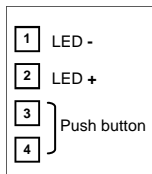
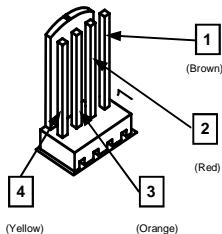
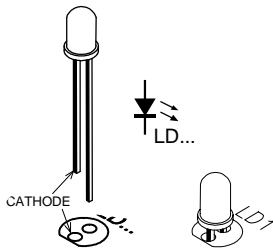

Fig. 3.0

- Slide the shrinkable tube over the soldered joints and heat them using a hair dryer or, better still, using a paint stripper.

☞ *In case you want to use a different push button, make sure it is rated for the AC-voltage.*

☞ *If you do not use the included push button, you can mount a 3mm LED on the PCB.*



Watch the polarity !

☞ **Do not use both simultaneously
(LED & included push button)**

19. Final connection & use



CAUTION: ALL PARTS OF THE CIRCUIT CARRY DANGEROUS VOLTAGES (MAINS)! OBSERVE ALL SAFETY REQUIREMENTS THAT MIGHT APPLY!

MOUNT THIS KIT PREFERABLY IN AN ISOLATED ENCLOSURE

- Connect your application (ex. lamp) to the unit (Lout & N)
- Connect the power supply to the power connections of the PCB (L & N), see fig. 4.0.

👉 **Warning:** It is important to position jumper JP1 in the correct mode prior to connecting the kit to the AC power

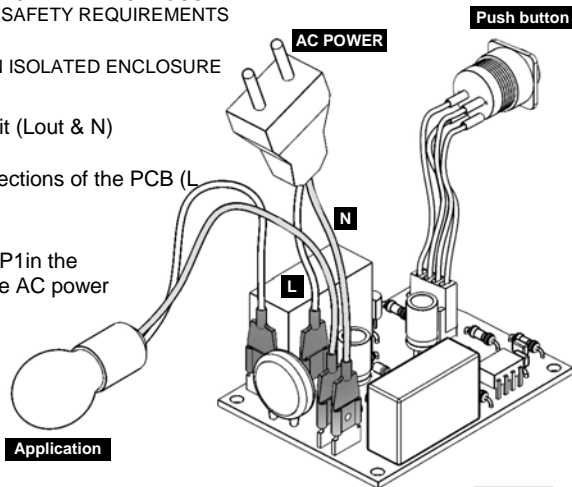

Fig. 4.0

👉 Never modify the JP1 mode setting while the unit is still live!

Jumper selection:

First, choose the desired timer function, i.e. a long-term or a short-term timer.

(1) Long-term timer.

- Mount the jumper (JP1)
- At power-on, the pushbutton LED (or LD1) will flash slowly twice, hereby indicating that long-term timers have been selected (2h or 8h turn-off timer).

(2) Short-term timer.

- Remove the jumper (JP1)
- At power-on, the pushbutton LED (or LD1) will flash fast twice, hereby indicating that short-term timers have been selected (1h or 4h turn-off timer).

Use :

Push button briefly: turn-on relay and toggle between a short or a long turn-off delay.

- Short turn-off delay (1h or 4h, depending on setting of jumper JP1)
 - ✓ Pushbutton LED (or LD1) blinks fast.
- Long turn-off delay (2h or 8h, depending on setting of jumper JP2)
 - ✓ Pushbutton LED (or LD1) blinks slowly.

Hold button for 2-3s: turn-on relay and activate 24h turn-off timer.

- ✓ Pushbutton LED (or LD1) is steady lit

Hold button again for 2-3s: turn-off relay

- ✓ Pushbutton LED (or LD1) is dimly lit

20. Schematic diagram

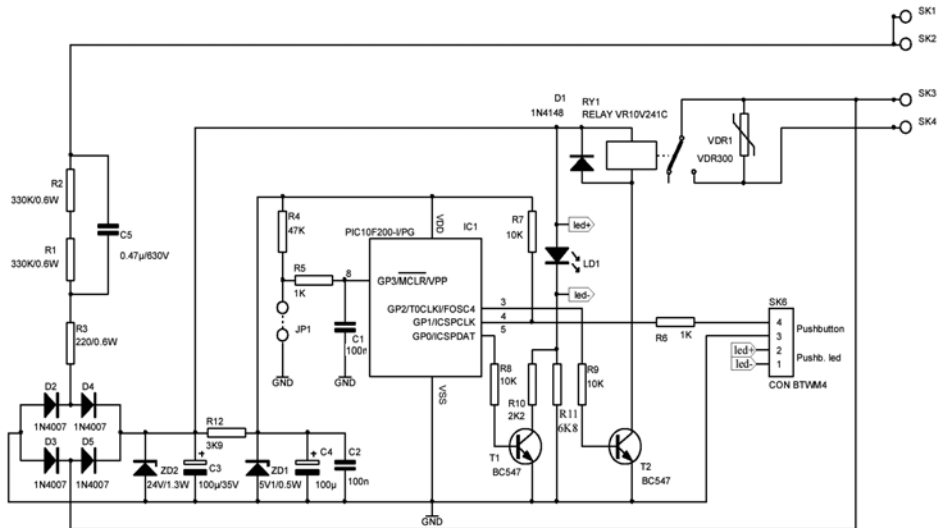

21. PCB

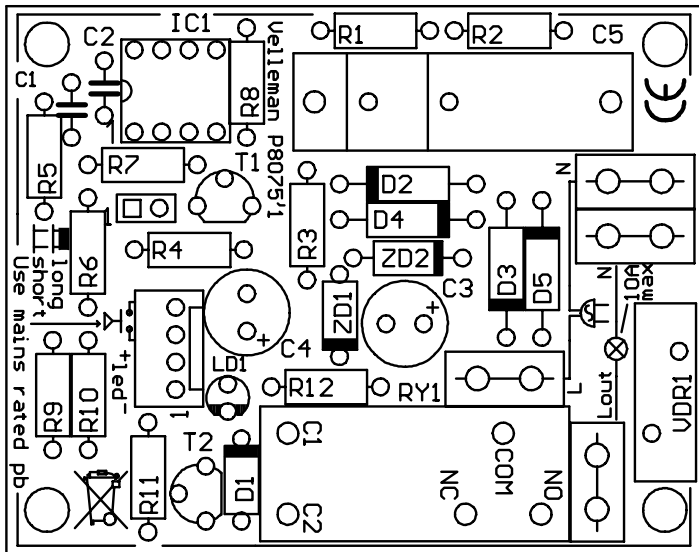



Modifications and typographical errors reserved
© Velleman Components nv.
H80751P - 2005 - ED1

